

WILCO

MANUFACTURING, LLC
Amphibious Hydraulic Undercarriages

Wilco Manufacturing Amphibious Hydraulic
Undercarriage
Model: WMB50502818CR



WMB50502818CR Amphibious Hydraulic Undercarriage Specifications

PONTOON CONSTRUCTION

High-Strength, Low Alloy, Weathering A606-4 steel plate is used in fabrication of the Wilco pontoons. This steel has 5 to 8 times the atmospheric corrosion resistance and 20% more tensile strength than similar size A36 structural plate steel. Each pontoon has 5 bulkheads, providing 6 independent watertight compartments. The bottoms of the pontoons are reinforced for rough terrain operations.

TRACK CHAINS

Three strands of specially designed, heavy duty, 4 or 5 inch pitch marsh buggy track chain are installed on each pontoon. The hardened track chain rollers run in pontoon channels lined with an abrasive resistant hardox wear bar. Drive and idler shaft sprockets are flame hardened to match the hardness of the track chain rollers.

DRIVE CHAINS

Engineering class 3.067 inch pitch high strength, heavy-duty offset drive chain is used to transfer power from the two-stage planetary final drive gear boxes to the drive shaft sprocket on each track.

TRACK SHOES

Specially designed marine grade, extruded 6061-T6 aluminum alloy cleats with 2 UHMW wear pads are capable of supporting the pontoon and its payload.

DRIVE SYSTEM

Power for the pontoon tracks is provided by the excavator's diesel engine and main hydraulic pumps through a hydraulic swivel. Hydraulic travel motors and brakes are mated to the sealed planetary final drives to provide independent power to each pontoon track. Standard excavator travel controls are used.

CARBODY

Wilco's specially designed carbody is built to accept up to a 30,000 lb. upper structure, which makes assembly and disassembly faster and easier.

Wilco Manufacturing Amphibious Hydraulic Undercarriage Specifications

Individual Pontoon Shipping Weights & Dimensions

Height... 1.75 m (5.79 ft) Length.... 9.52 m (31.25 ft)
Width..... 2.15 m (7.08 ft) Weight.... 7500 kg (16,500 lb)

*All weights and measurements are approximate

Basic Undercarriage Weight:
18,144 kg (40,000 lb)

Upper Capacity:
13,608 kg (30,000 lb)

Gross Weight:
31,752 kg (70,000 lb)

*All weights and measurements are approximate

*All measurements are approximate

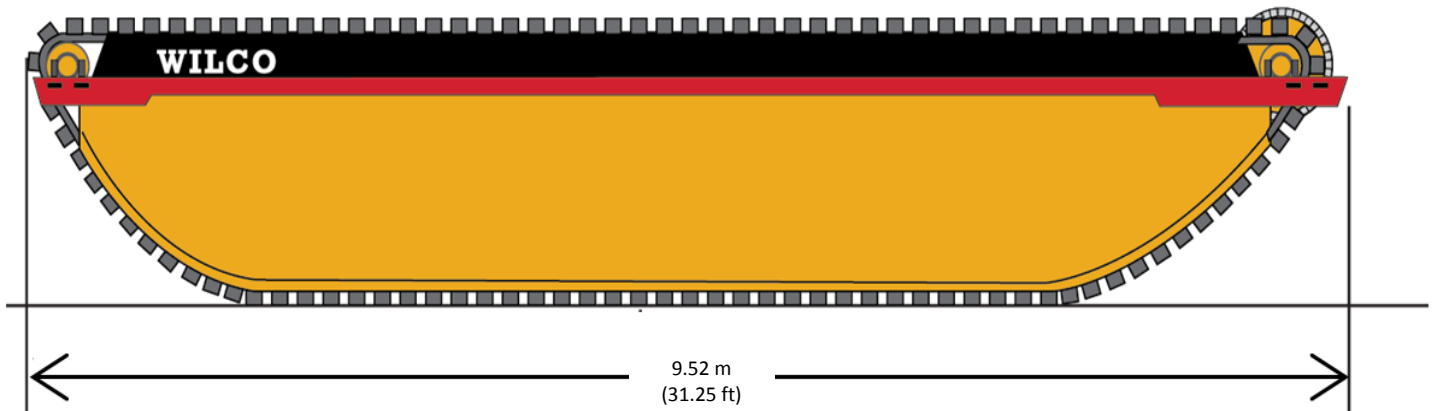

*All measurements are approximate

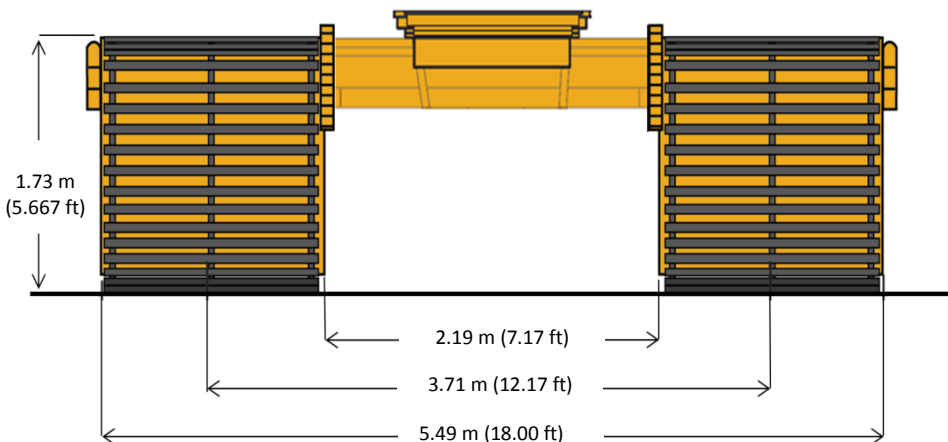

WILCO

Wilco Manufacturing L.L.C.

P.O. Box 80829

Lafayette, LA 70598

Tel: 337.235.1715

Fax: 337.233.3511

www.wilcomanufacturing.com